

Specifications

Disposal Description

- Professional 3-bolt mounting system provides an easy and durable installation
- 1/3 HP permanent magnet motor delivers 1900 rpms of grinding power and reduces jams
- Pre-installed power cord for easy plug-in install, no hardwiring or separate purchase required
- Galvanized steel grinding components
- Reinforced polymer grind chamber resists corrosion and extends disposal life
- Continuous feed disposal activates via a wall switch or sink-mounted air switch
- Compact, lightweight design saves space
- Safe to use with properly sized septic tanks
- Front-mounted reset button

Included Components

- Waste King 9910 3-Bolt Mount Disposal Unit
- Pre-installed power cord
- Stainless steel sink flange and drain stopper
- Drain elbow and 3-Bolt mounting assembly

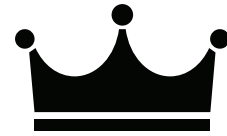

WASTE KING Model 9910



Critical Dimensions

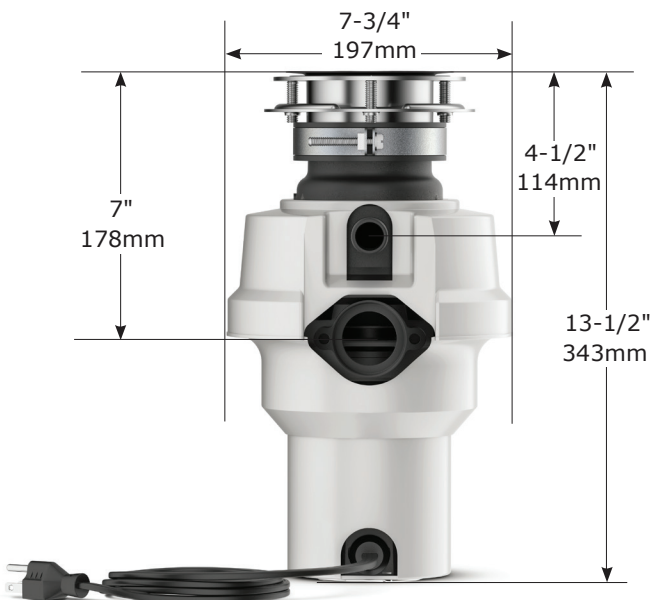

Weight 8.6 lbs.

Two Year Limited Warranty

If the disposal develops a material or mechanical defect during the warranty period, Waste King will replace it free of charge.

Specification Detail

Specification Detail	
Motor Horsepower	1/3 H.P.
R.P.M.	1900
Mount	3-Bolt Mount
Sound Insulation	No
Warranty	Two Year Limited
Voltage, HZ	115, 60
Current-Amps	4.0
Power Cord	Pre-Installed
Motor Type	Permanent Magnet
On/Off Control	Wall Switch
Drain Connection Size	1-1/2 inch drainpipe
Dishwasher Compatibility	7/8 inch rubber dishwasher drain hose
Maximum Sink Thickness	1/2 inch
Sink Flange Material	Stainless Steel
Sink Flange Finish	Stainless Steel
Splash Guard	Not Removable
Feed	Continuous
Internal Grind Component Material	Galvanized Steel
Grind Chamber Material	Reinforced Polymer
Overload Protector	Manual Reset Type

FOR MORE INFORMATION CALL: **1-800-854-3229**
WasteKing.com